

Slim Duct

Models (Drain pump internal model)

- ARXD07LATH
- ARXD09LATH
- ARXD12LATH
- ARXD14LATH
- ARXD18LATH
- ARXD24LATH



ARXD07LATH ARXD09LATH ARXD12LATH ARXD14LATH



ARXD18LATH



ARXD24LATH

Slim design and wide range of static pressure for flexible installation.

Slim design

This model is slim design, it can install at the place where a ceiling is narrow.

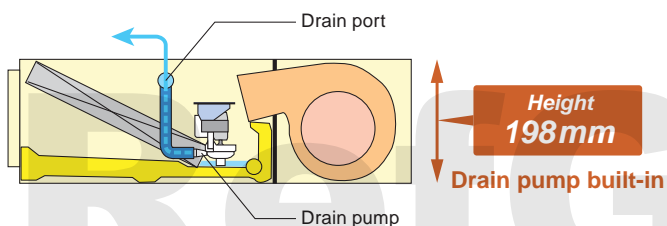

Flexible installation

Ceiling concealed

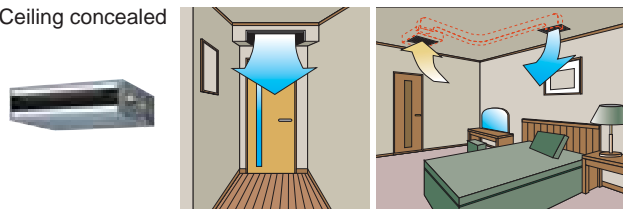

Floor concealed

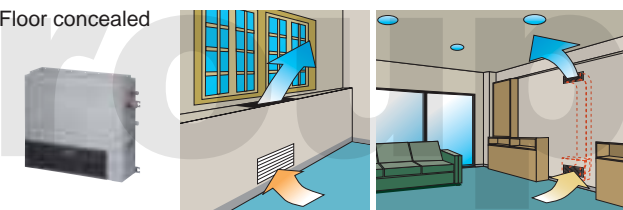

Specifications

Model name			ARXD07LATH	ARXD09LATH	ARXD12LATH	ARXD14LATH	ARXD18LATH	ARXD24LATH
Power source			230V ~, 50Hz					
Capacity	Cooling	kW	2.2	2.8	3.6	4.5	5.6	7.1
	Heating		2.8	3.2	4.0	5.0	6.3	8.0
Input power		W	44	50	54	92	83	122
Airflow rate	High	m ³ /h	550	600	600	800	940	1,330
	Med		490	550	510	710	840	1,240
	Low		440	480	450	610	750	1,100
Static pressure range		Pa	0 to 90					
Standard static pressure			25	25	25	25	25	25
Sound pressure level	High	dB(A)	28	29	30	34	34	35
	Med		25	26	27	32	32	32
	Low		22	24	24	28	28	29
Dimensions (H x W x D)		mm	198 x 700 x 620				198 x 900 x 620	198 x 1,100 x 620
Weight		kg	18		19		23	27
Connection pipe diameter	Liquid (Flare)	mm	ø6.35				ø9.52	
	Gas (Flare)		ø12.70				ø15.88	
	Drain		ø22 (I.D.) ; ø26 (O.D.) : VP20					

Note : Specifications are based on the following conditions.

Cooling : Indoor temperature of 27°CDB / 19°CWB, and outdoor temperature of 35°CDB / 24°CWB.
 Heating : Indoor temperature of 20°CDB / (15°CWB), and outdoor temperature of 7°CDB / 6°CWB.
 Pipe length : 7.5 m; Height difference between outdoor unit and indoor unit : 0 m.

High lift drain pump

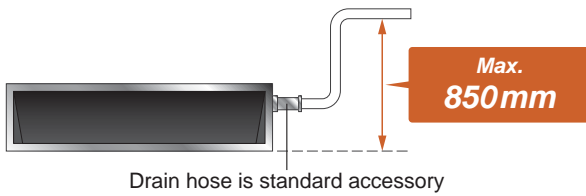

Selectable with a wide range of static pressure

By using DC fan motor, it is possible to change of static pressure range 0 to 90Pa. The change of static pressure range is possible by remote controller.



Static pressure range
0 to 90 Pa

*24 model is 0 to 50Pa

Auto Louver Grille Kit (Option)

Simple flat Auto Louver will provide comfort airflow and harmonize with luxury interior.

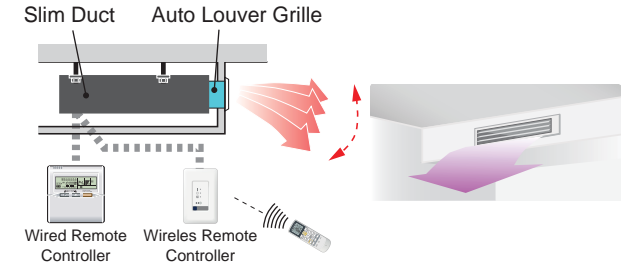

Filter (Accessory)

ARXD07 / 09 / 12 / 14 / 18

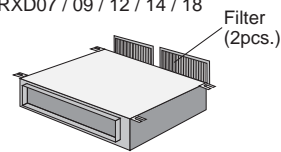

ARXD24

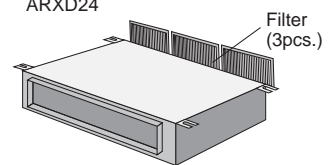

Air-intake

Air intake direction can be selected to match the installation site.

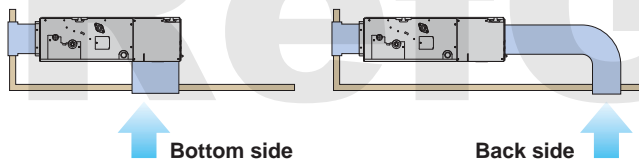

Optional parts

Remote Sensor Unit : UTD-RS100

IR Receiver Unit : UTB-*WB

Auto Louver Grille Kit : UTD-GXSA-W (for ARXD07/09/12/14LATH)
UTD-GXSB-W (for ARXD18LATH)
UTD-GXSC-W (for ARXD24LATH)

*WB : YWB, TWB

Dimensions (Unit : mm)

Models: ARXD07LATH / ARXD09LATH / ARXD12LATH / ARXD14LATH / ARXD18LATH / ARXD24LATH

*Service accessibility must be allowed for when installing the product.

Please consult the installation manual for the necessary service access size.

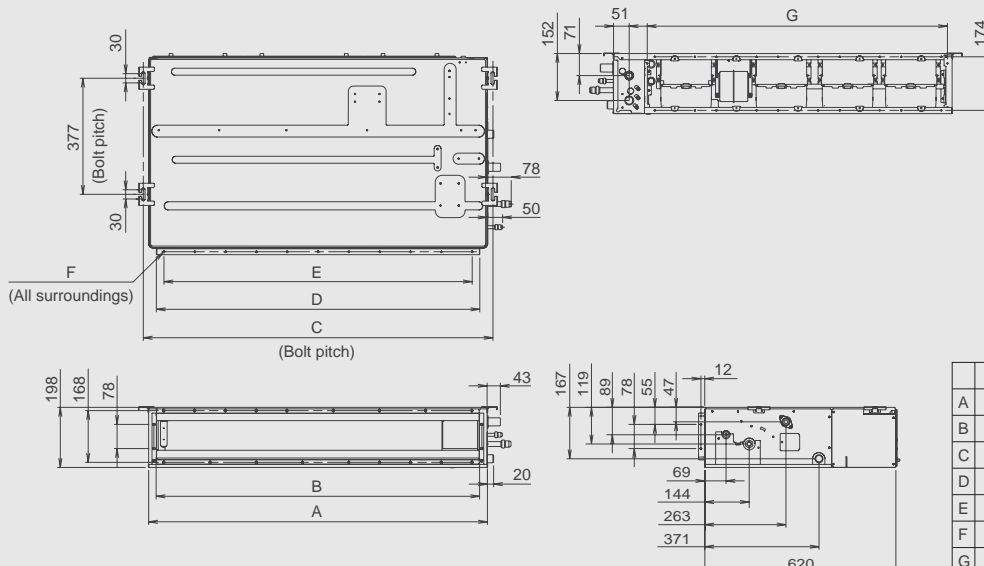

	ARXD07-14LATH	ARXD18LATH	ARXD24LATH
A	700	900	1100
B	650	850	1050
C	734	934	1134
D	650	850	1050
E	P100x6=600	P100x8=800	P100x10=1000
F	18xØ5	22xØ5	26xØ5
G	574	774	974